

Page 1 A



**RUBY SAREE BL**  
with seam allow

**Size: XS**

**BACK  
cut 2**



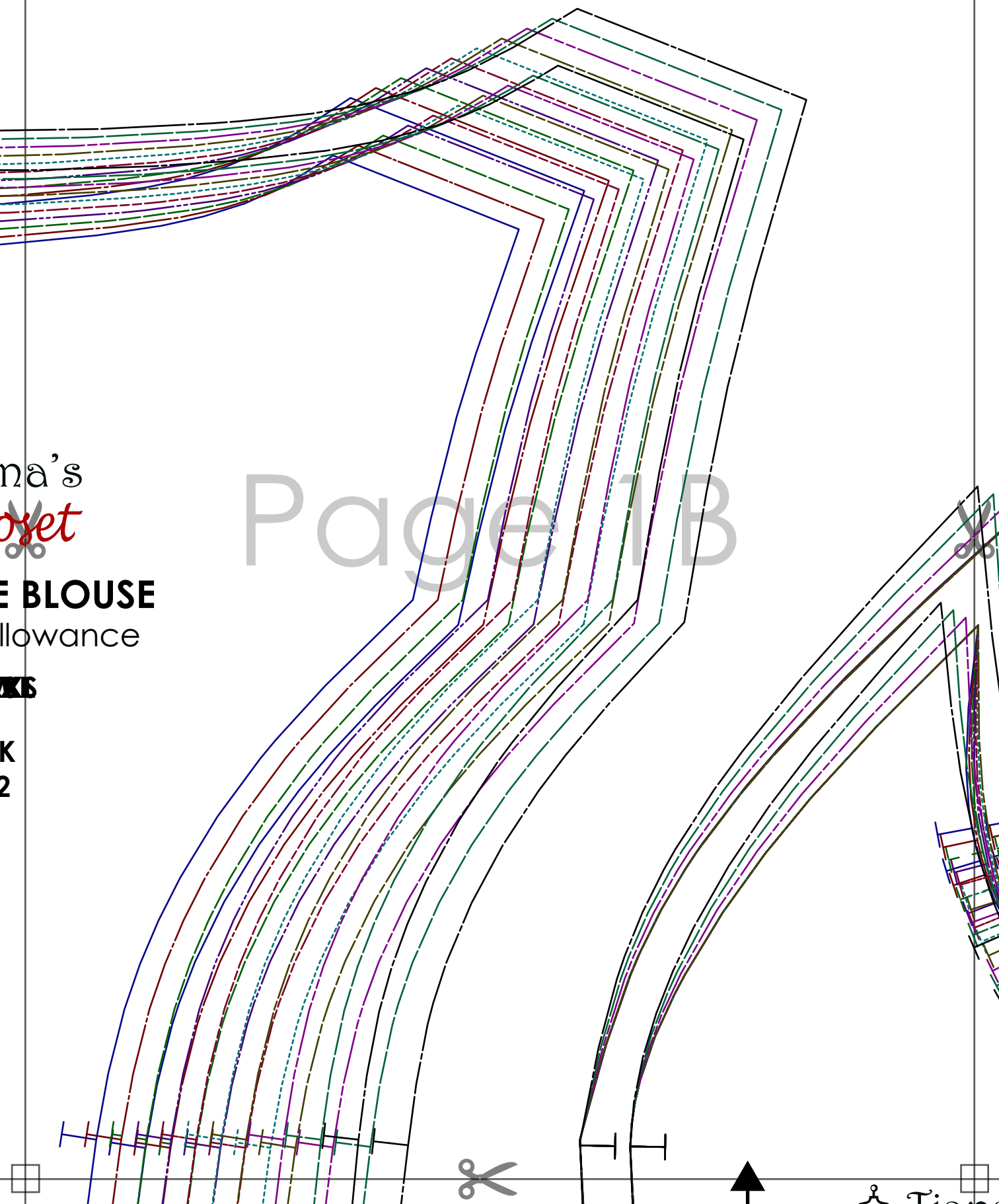

ma's  
*ojet*  
**E BLOUSE**  
 allowance

Page 1B

**KS**

**K  
2**



 **Time**

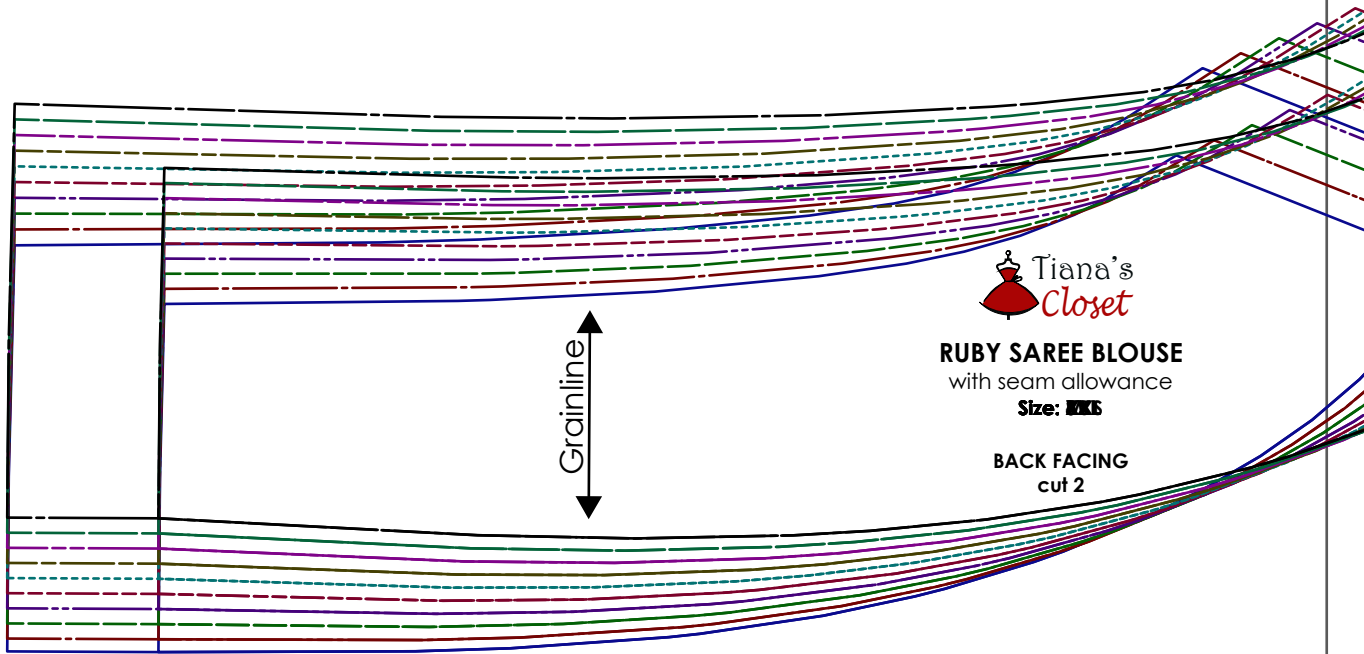

**RUBY SAREE BLOUSE**  
with seam allowance  
Size: **M**

**BACK FACING**  
cut 2

Page 1C

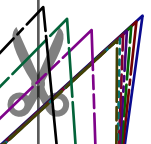

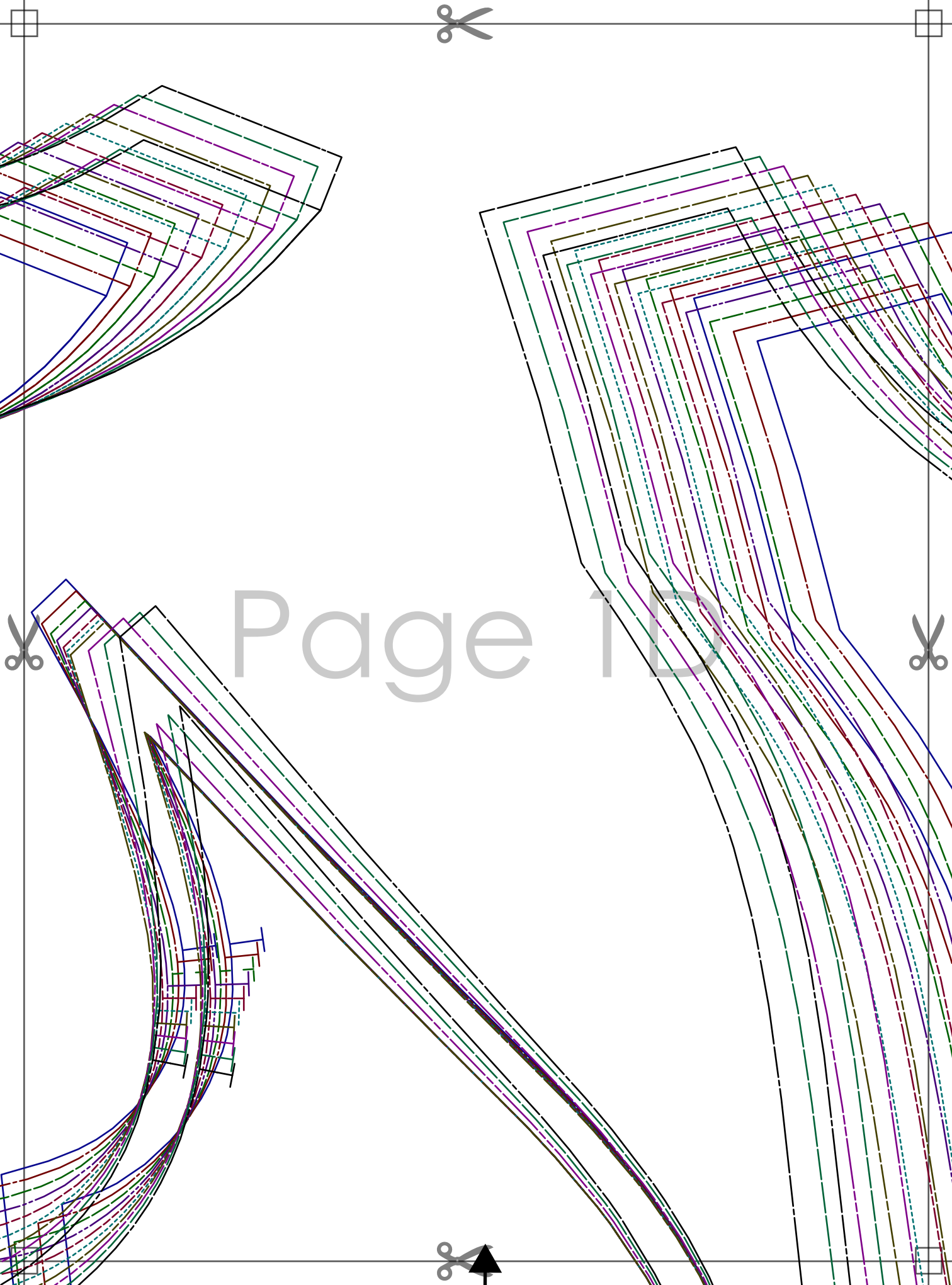

Page 10

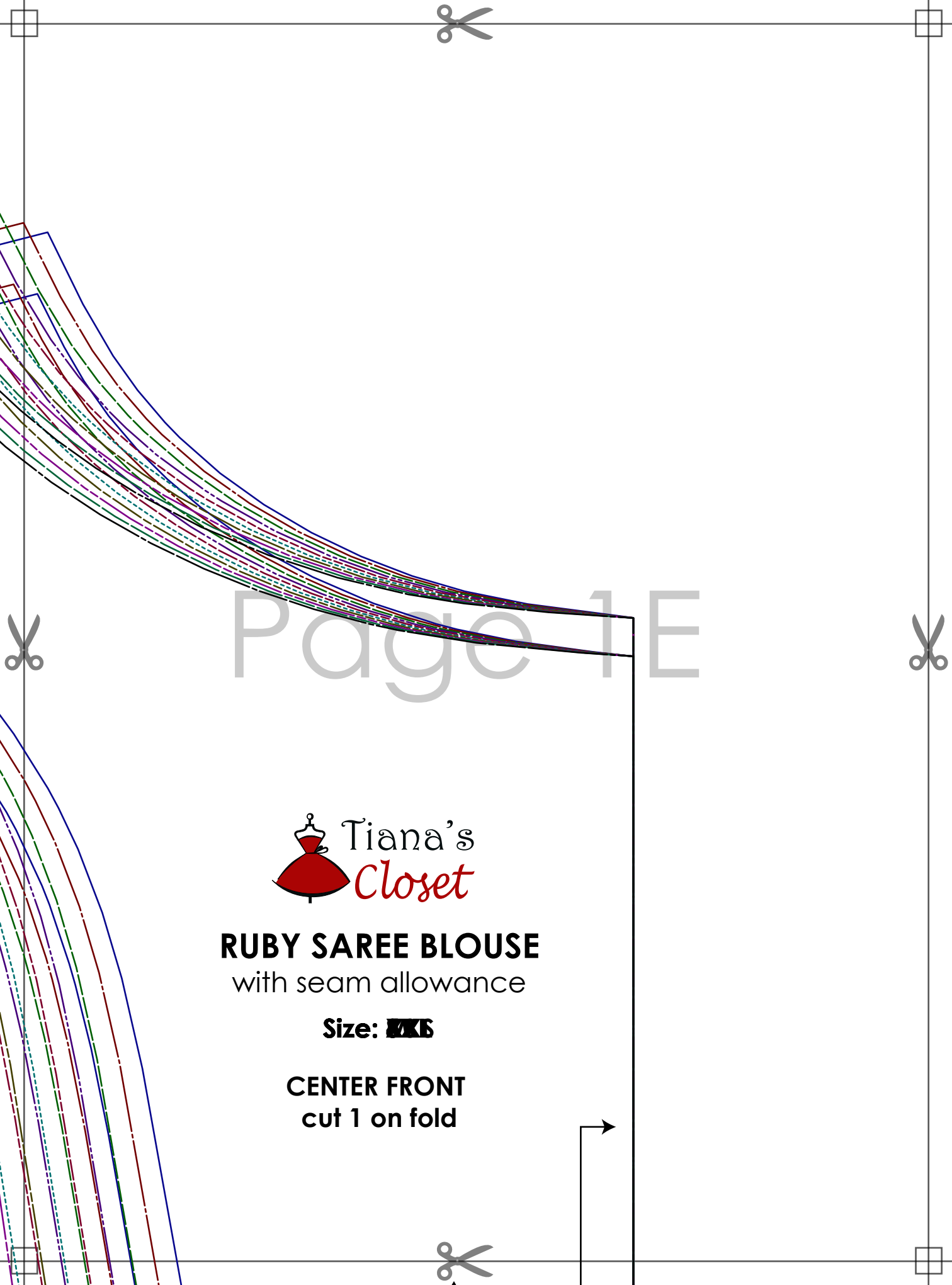

Page 1 E



**RUBY SAREE BLOUSE**  
with seam allowance

**Size: XXXS**

**CENTER FRONT**  
cut 1 on fold



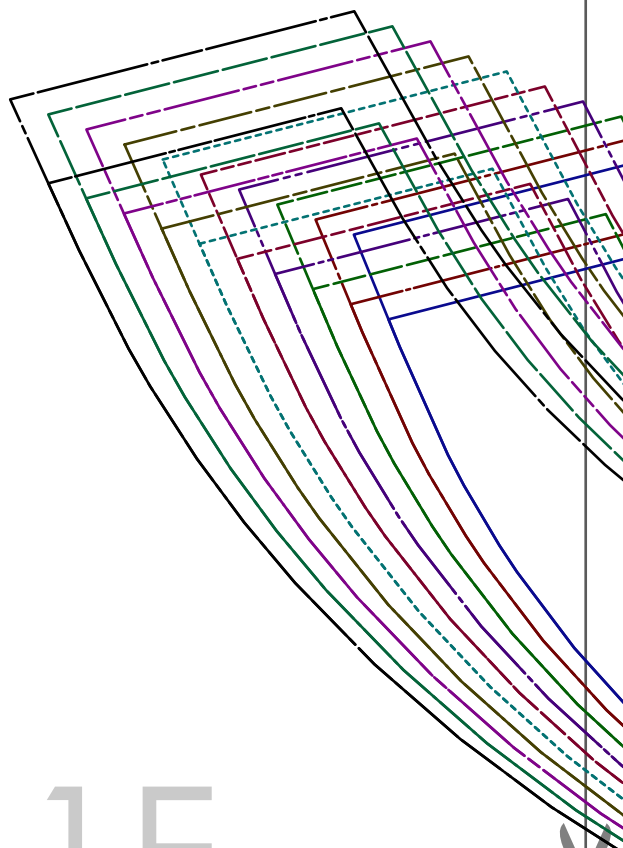

Page 1F

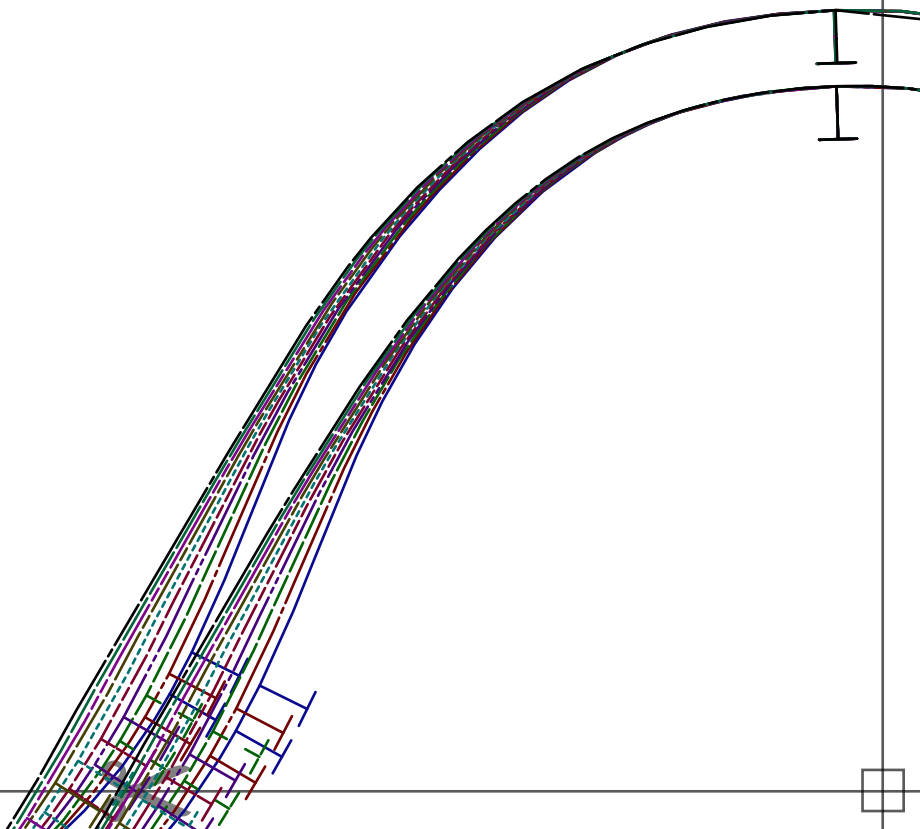

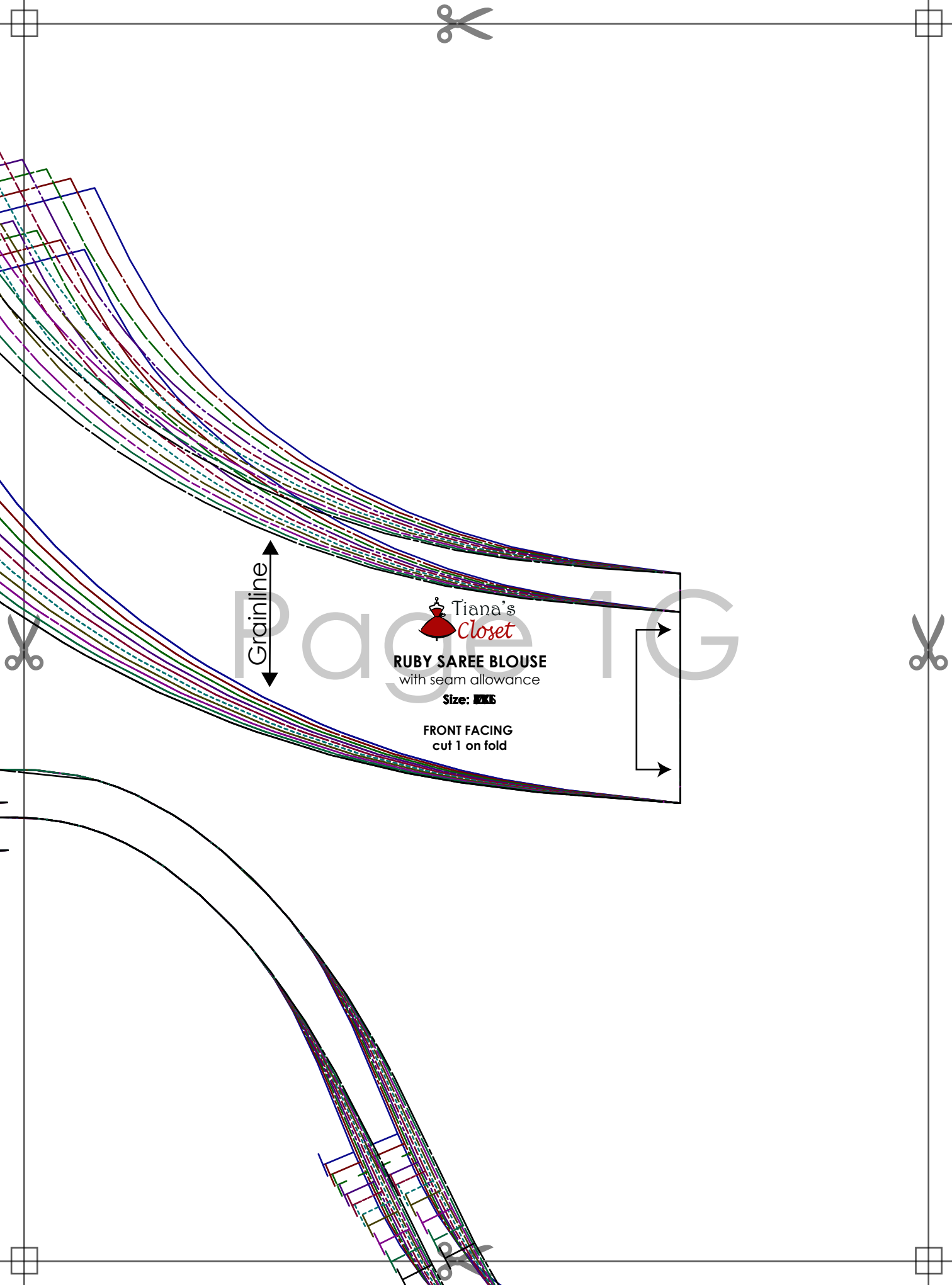

Grainline



Tiana's  
*Closet*  
**RUBY SAREE BLOUSE**  
with seam allowance

Size: **XL**

**FRONT FACING**  
cut 1 on fold

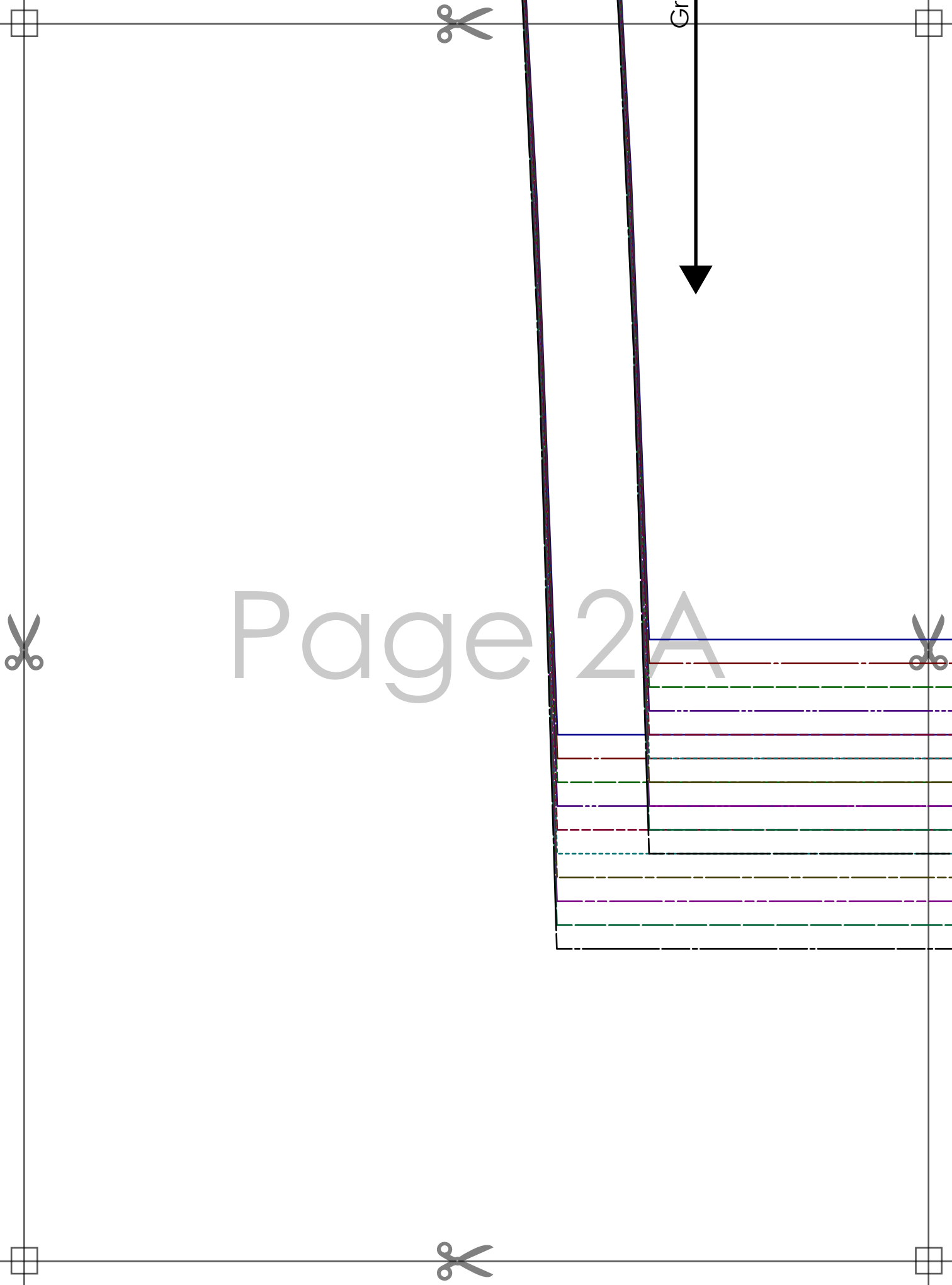

Page 2A

Gr

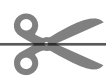
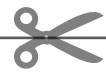
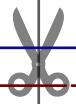





Tiana's

Closet

# RUBY SAREE PATTERN

with seam allowance

Size: **XXXXL**

**SIDE BACK**  
cut 2

Grainline

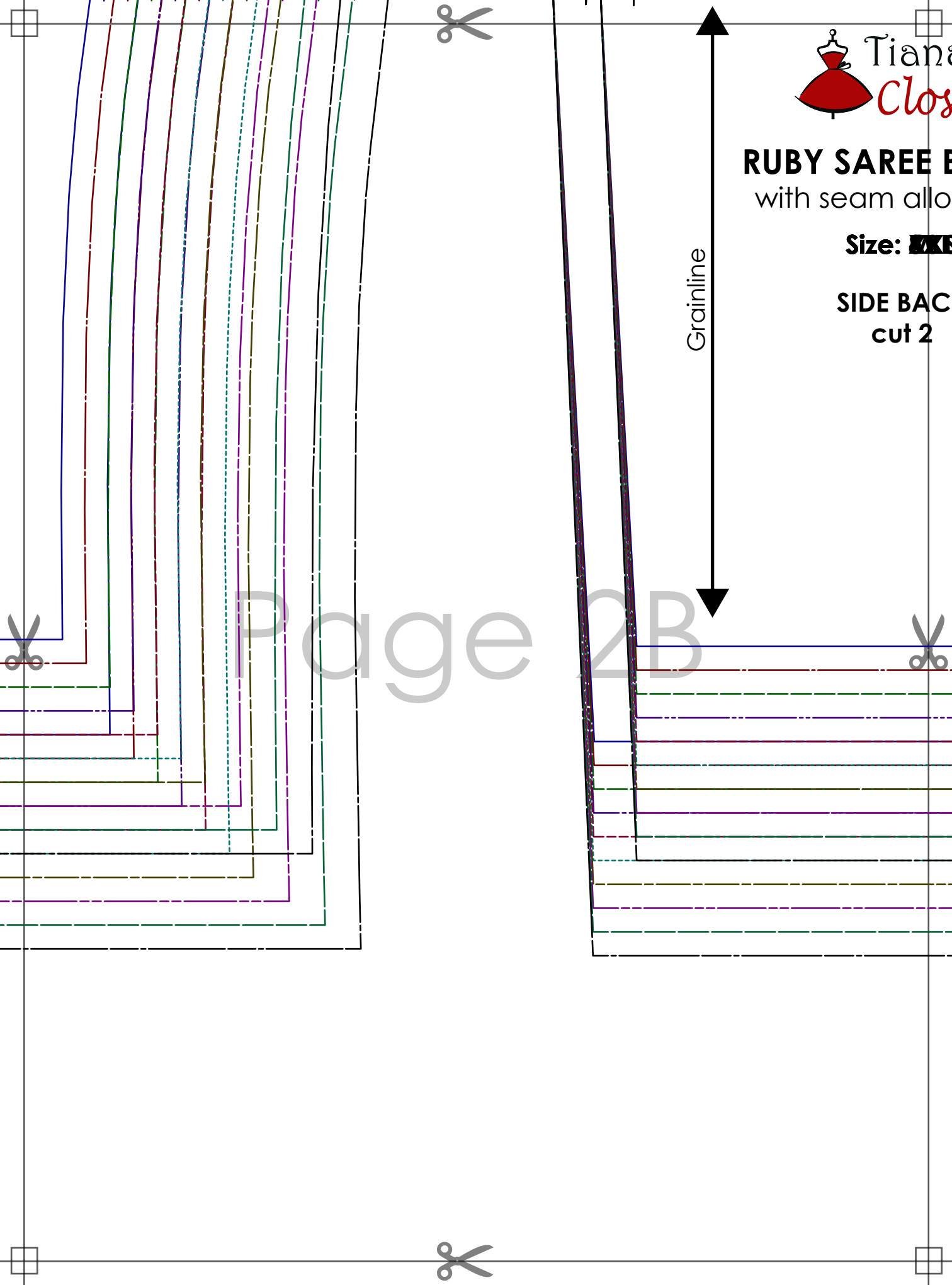

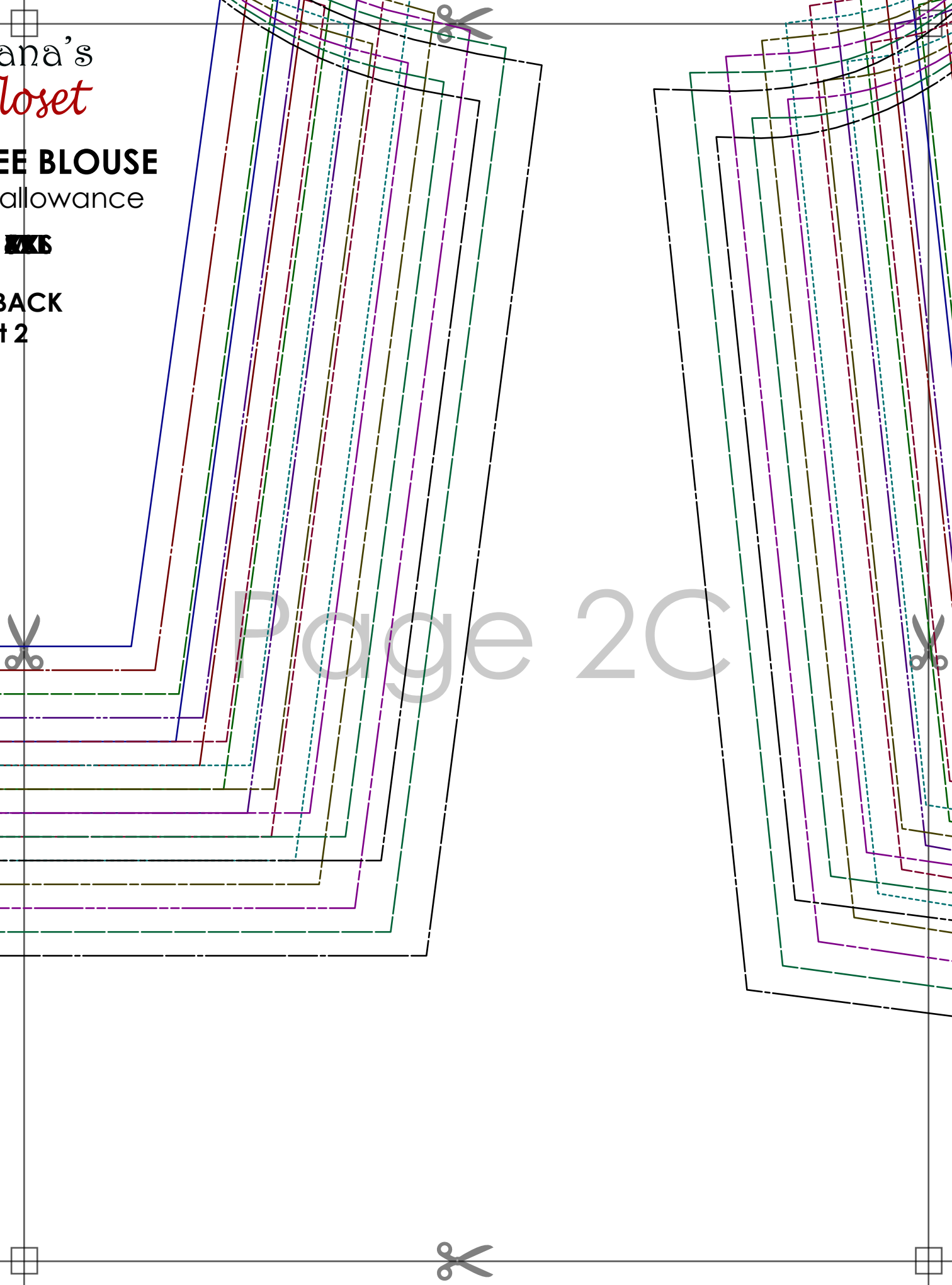

ana's  
*loset*

**EE BLOUSE**

allowance

**XS**

**BACK**

**+ 2**

Page 2C



Tiana's  
*Closet*

# RUBY SAREE BLOUSE

with seam allowance

Size: **XXS**

**SIDE FRONT**  
cut 2

Grainline

Page 2D

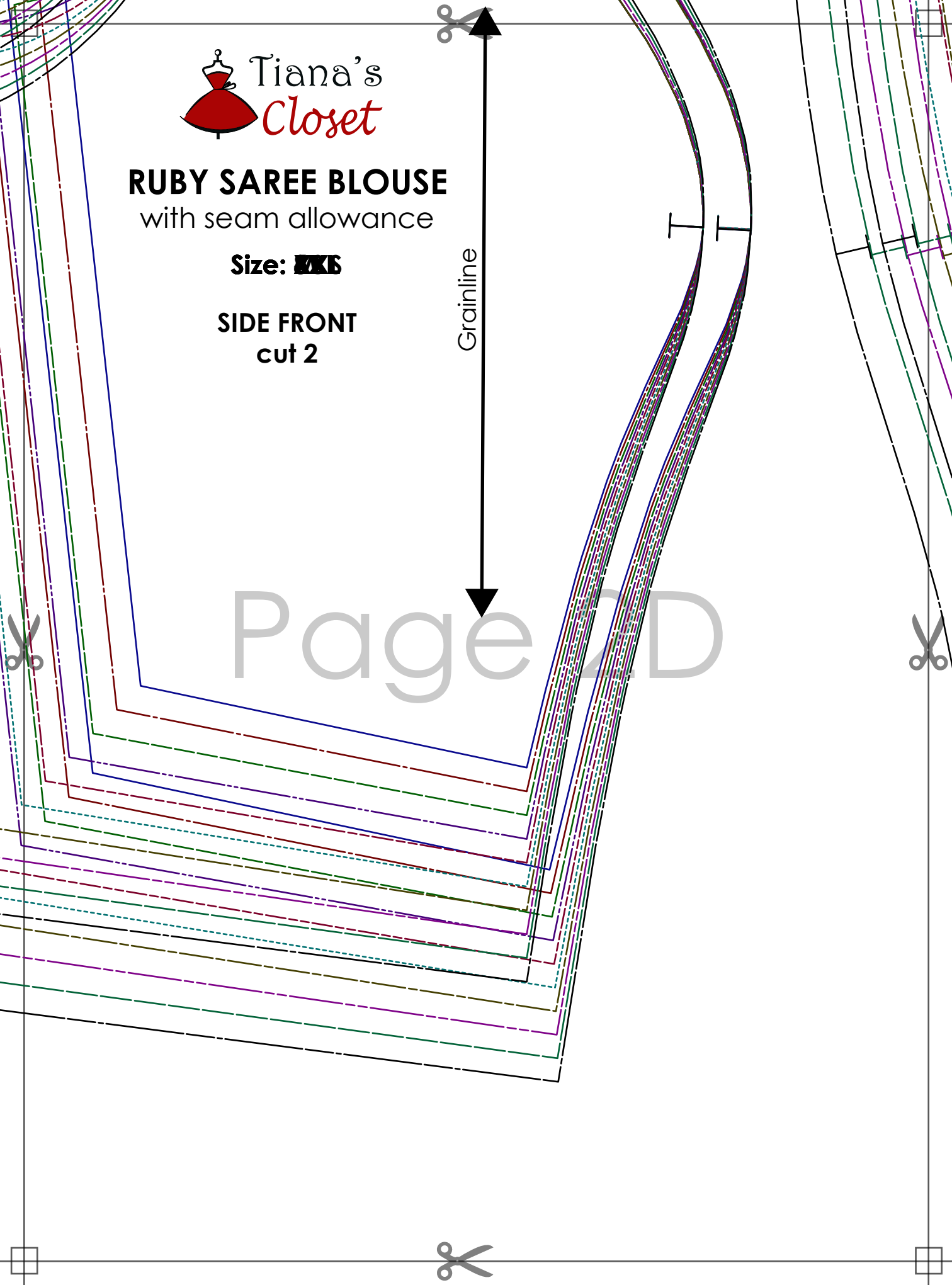

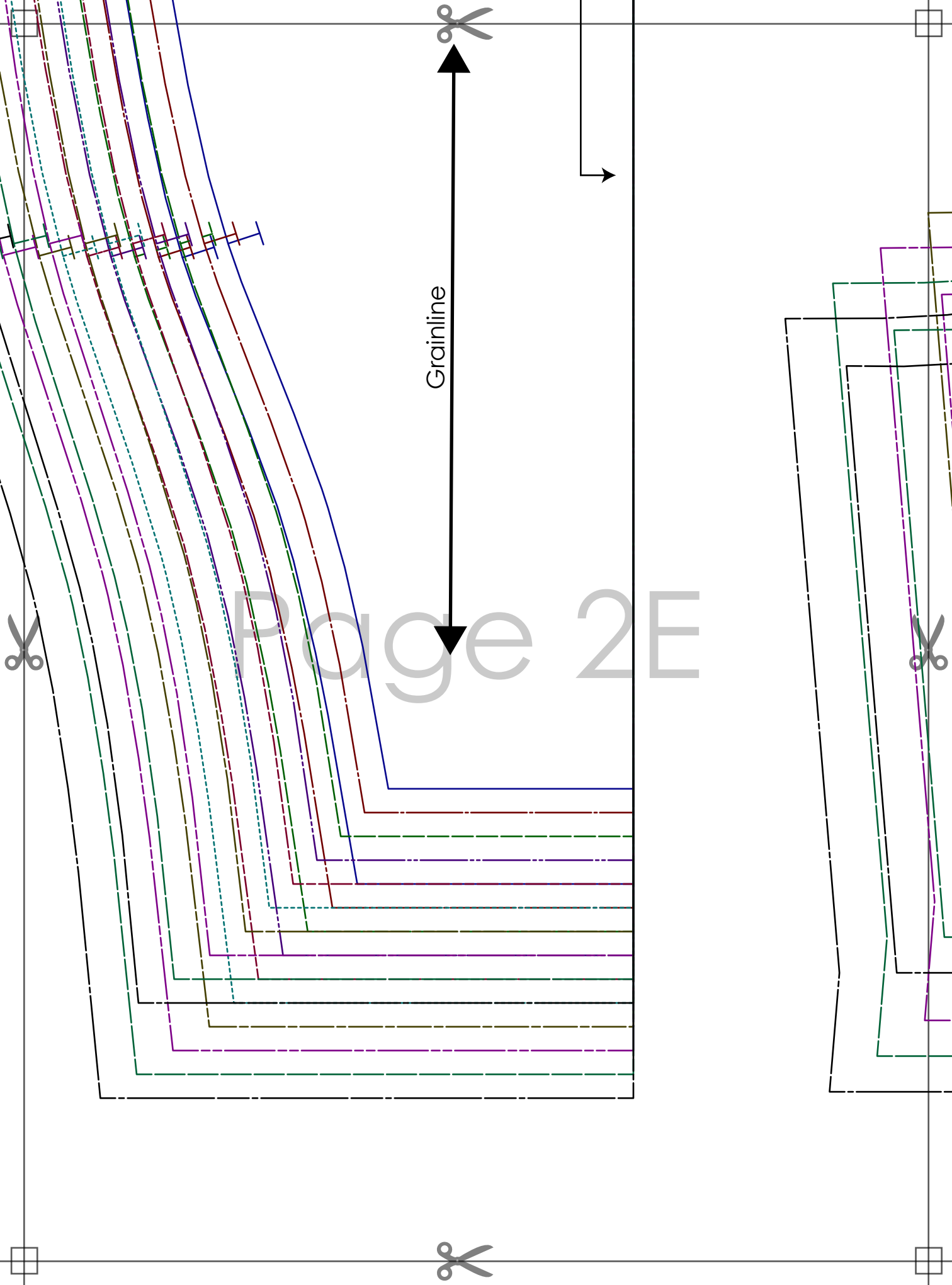

Grainline

Page 2E



# RUBY SAREE BLOUSE

with seam allowance

Size: ~~M~~ ~~L~~ **S**

**SLEEVE**  
cut 2

Page 2F

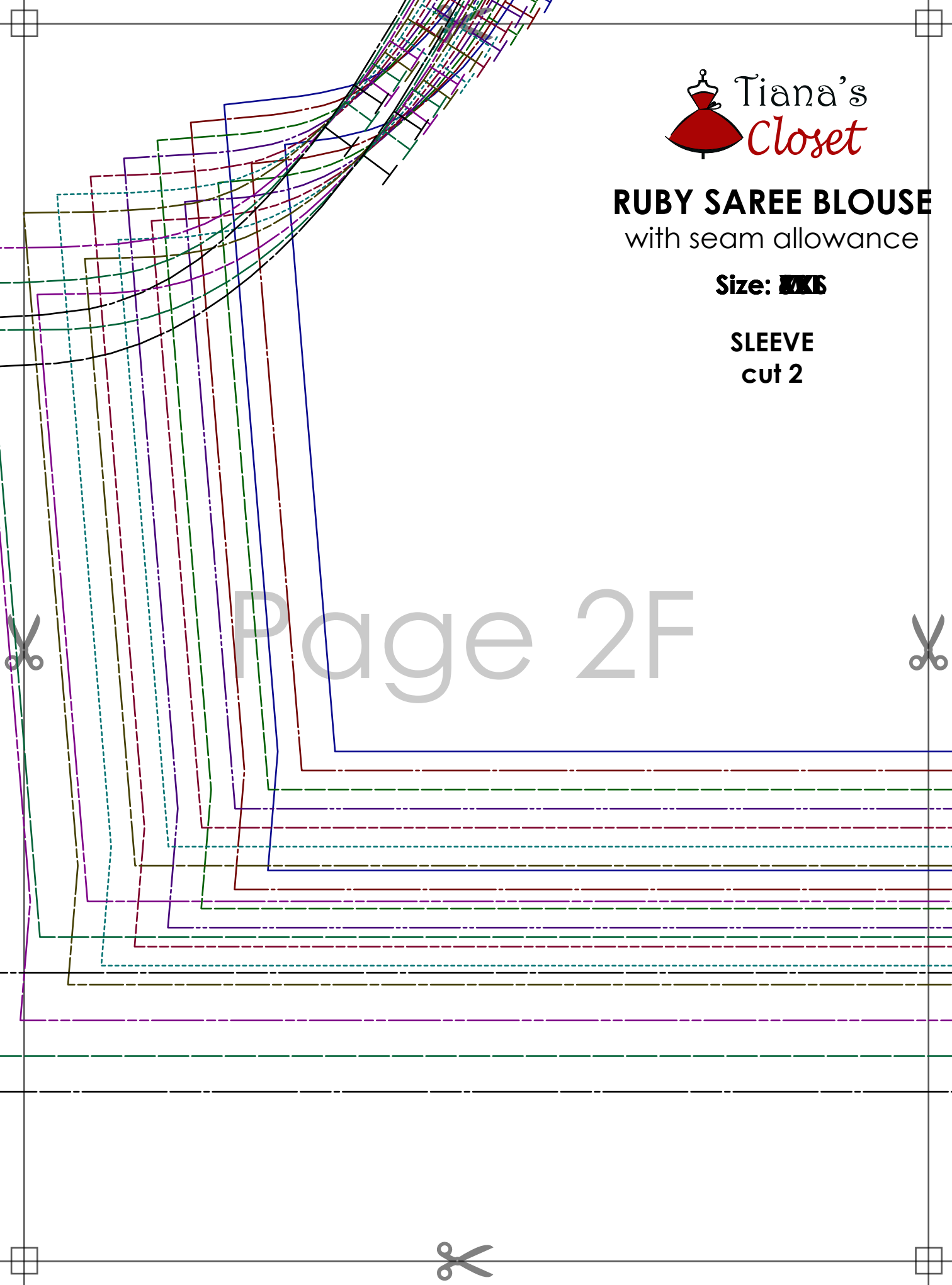

SE  
e



Page 2G

